

Exposition of proposal for Addendum phase wef 1 April 2010 - Version 6 - updated on 14 July 2010

THIS EXPOSITION IS FOR ILLUSTRATIVE PURPOSES - IT DOES NOT FORM PART OF PHSDSBC RESOLUTION 1 OF 2010

Medical Officer

Arrows show translation methodology

Existing scales

Proposed scales

Medical Intern

253,998
257,808

No Translation

Medical Practitioner (Comserv)

340,557

No Translation

Medical Practitioner

Grade 1

405,333
417,582
430,206
443,208
456,606

Proposed

423,846
430,206
436,656
443,208
449,856
456,606

Grade 1

Grade 2

470,406
484,623
499,269
514,359
529,905

484,623
491,892
499,269
506,757
514,359
522,072
529,905

Grade 2

Grade 3

554,109
562,422
570,858
579,420
588,114
596,934
605,886
614,976
624,198
633,561
643,065
652,710
662,502

562,422
570,858
579,420
588,114
596,934
605,886
614,976
624,198
633,561
643,065
652,710
662,502
672,438
682,527
692,763
703,155

Grade 3

Additional notches

Clinical
Manager
(Medical)
App: 6 years

1st Supervisory level

Proposed

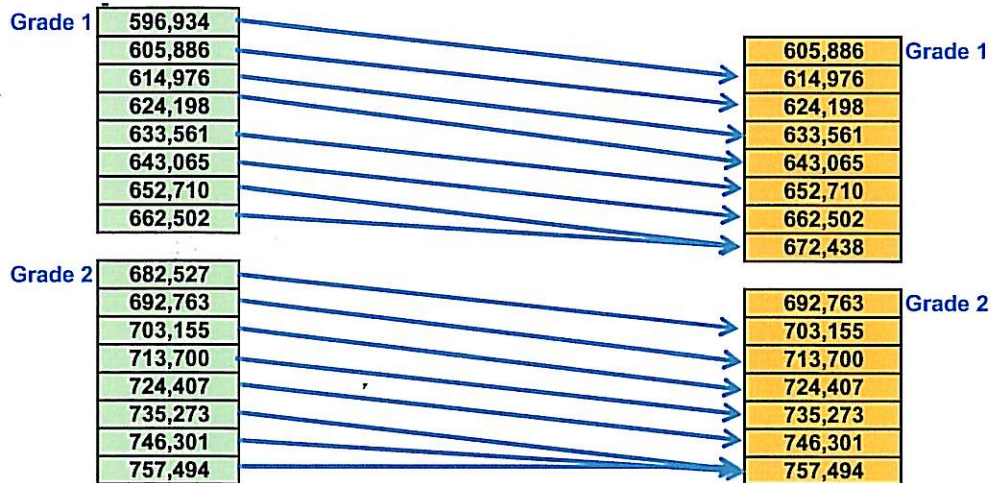

Clinical Managers (Medical), who were Chief Medical Officers pre-OSD, and who occupied a post where it was required to formally supervise more than one post of Chief Medical Officer (pre-OSD) and who meet the prescribed requirements, are eligible for translation to the new OSD post

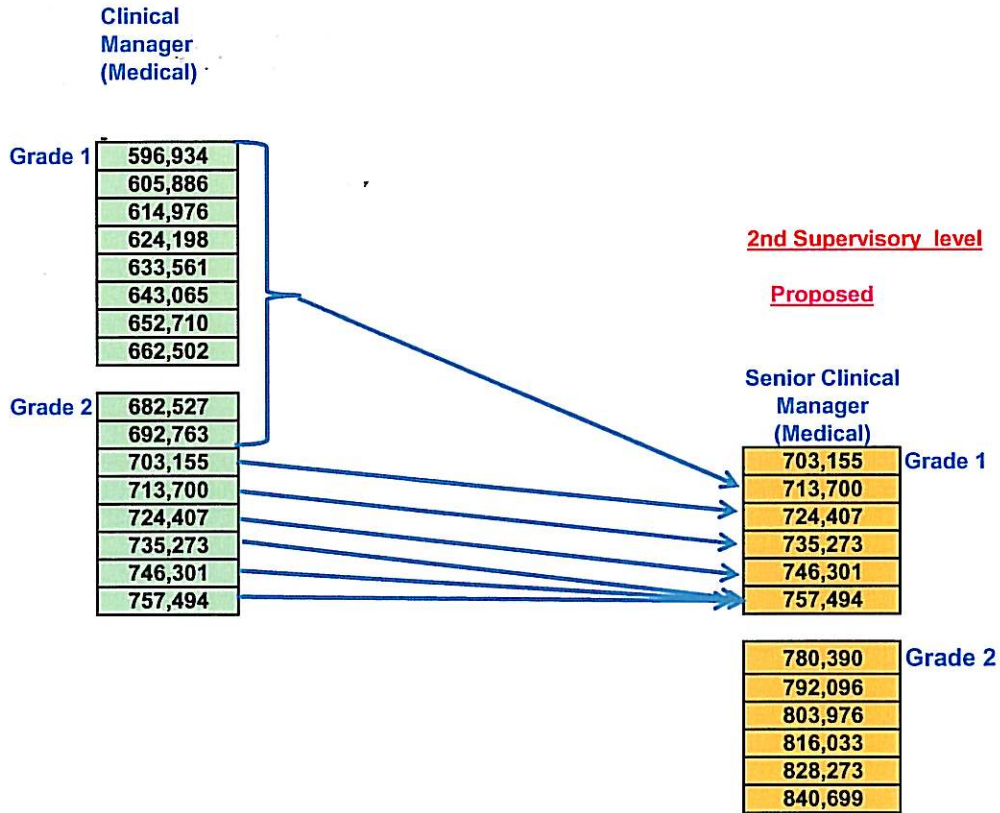

Dentist

Dentist
(Comserv)

340,557

No Translation

Dentist

Production level

Grade 1

381,900

393,444

405,333

417,582

430,206

443,208

456,606

Proposed

411,411
417,582
423,846
430,206
436,656
443,208
449,856
456,606

Grade 1

Grade 2

470,406

484,623

499,269

514,359

529,905

484,623
491,892
499,269
506,757
514,359
522,072
529,905

Grade 2

Grade 3

554,109

562,422

570,858

579,420

588,114

596,934

605,886

614,976

624,198

633,561

643,065

652,710

662,502

562,422
570,858
579,420
588,114
596,934
605,886
614,976
624,198
633,561
643,065
652,710
662,502
672,438
682,527
692,763
703,155

Grade 3

Additional notches

1st Supervisory level

Clinical Manager (Dental)
App: 6 years

Proposed

Current Grade	Current Salary	Proposed Salary	Proposed Grade
Grade 1	596,934	605,886	Grade 1
	605,886	614,976	
	614,976	624,198	
	624,198	633,561	
	633,561	643,065	
	643,065	652,710	
	652,710	662,502	
	662,502	672,438	
Grade 2	682,527	692,763	Grade 2
	692,763	703,155	
	703,155	713,700	
	713,700	724,407	
	724,407	735,273	
	735,273	746,301	
	746,301	757,494	

Clinical Managers (Dental), who were Chief Dentists pre-OSD, and who occupied a post where it was required to formally supervise more than one post of Chief Dentist (pre-OSD) and who meet the prescribed requirements, are eligible for translation to the new OSD post

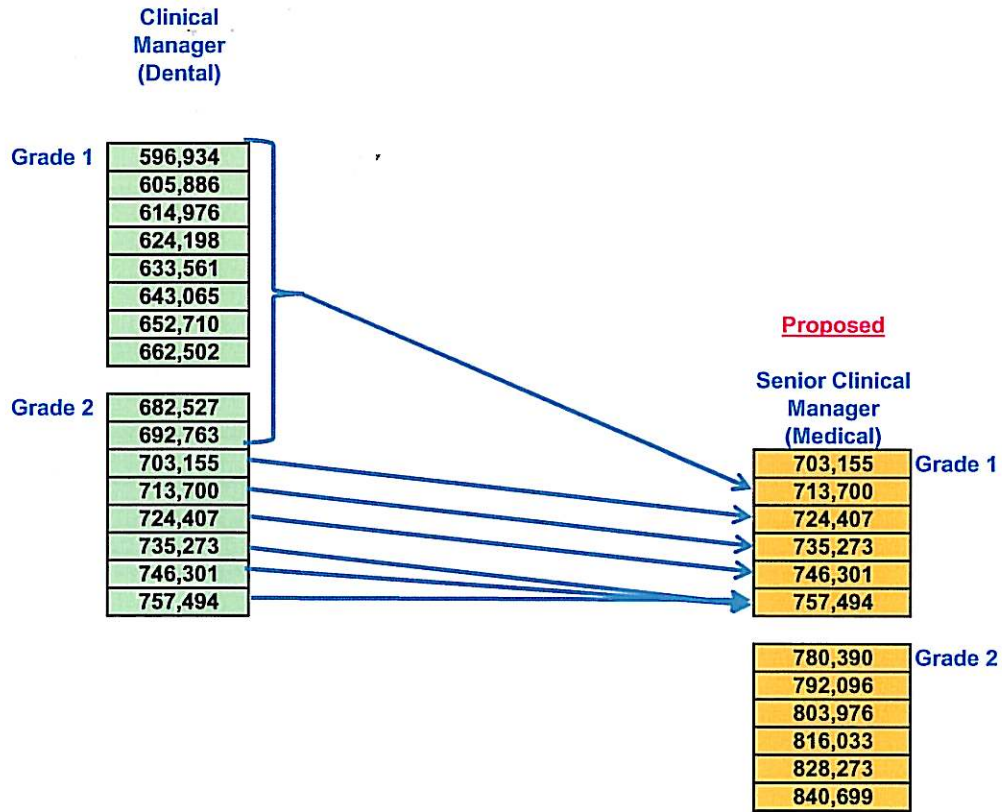

Specialist

Registrar (Medical)
Registrar (Dental)

(incl Com.
Overtime)

423,846
430,206
436,656
443,208

No Translation

Medical Specialist
Dental Specialist
(General Specialty)

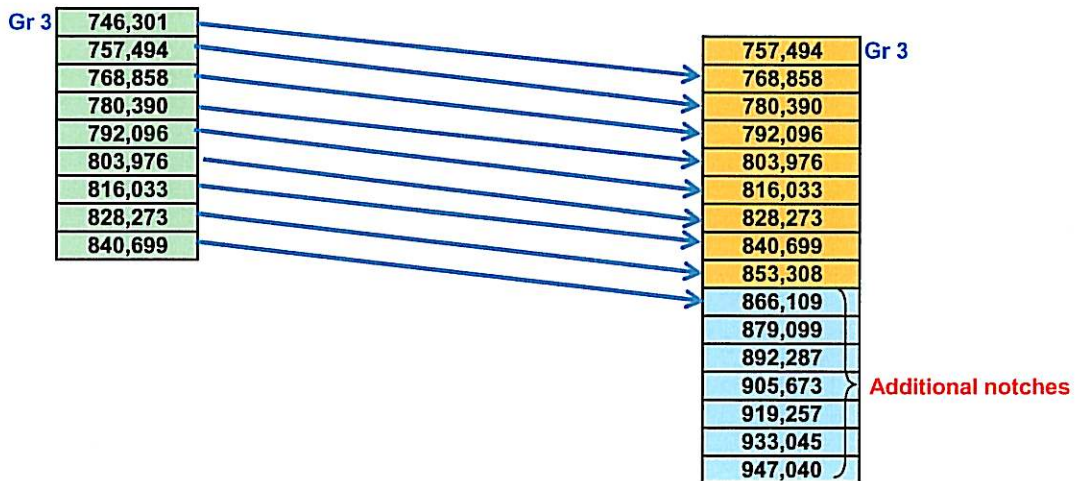
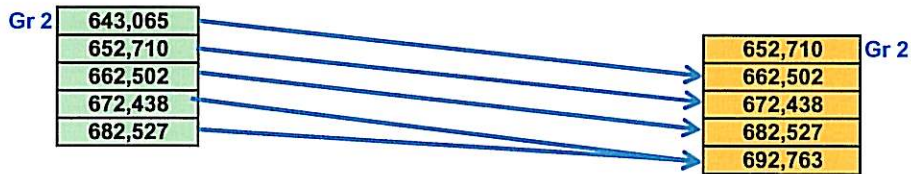
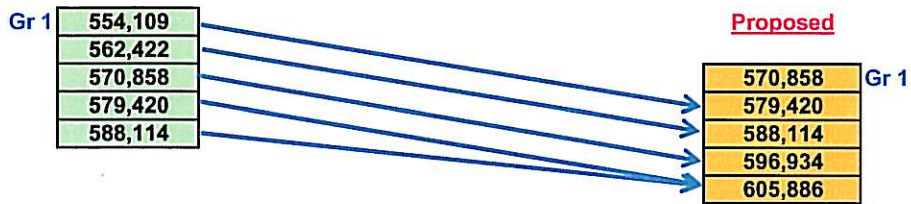

Snr Registrar (Medical)
Snr Registrar (Dental)

554,109	→	Proposed	570,858
562,422			579,420
570,858			588,114
579,420			596,934

Medical Specialist
Dental Specialist
(Sub-specialty)

Grade 1	643,065	→	Proposed	Grade 1	662,502
	652,710				672,438
	662,502				682,527
	672,438				692,763
	682,527				703,155

Grade 2	746,301	→	Grade 2	757,494
	757,494			768,858
	768,858			780,390
	780,390			792,096
	792,096			803,976

Grade 3	816,033	→	Grade 3	828,273
	828,273			840,699
	840,699			853,308
	853,308			866,109
	866,109			879,099
	879,099			892,287
	892,287			905,673
	905,673			919,257
				933,045
	947,040			

Head: Clinical Unit

App: 7 years

Grade 1	892,287
	905,673
	919,257
	933,045
	947,040

No Translation

Grade 2	975,666
	990,300
	1,005,153
	1,020,231
	1,035,534
	1,051,068
1,066,833	

Head: Clinical Department

App: 9 years

Grade 1	1,115,565
	1,132,299
	1,149,285
	1,166,523
	1,184,019

No Translation

Grade 2	1,219,809
	1,238,106
	1,256,679
	1,275,528
	1,294,662

Stomatologist and Clinical Pharmacologist

Stomatologist
Clinical Pharmacologist

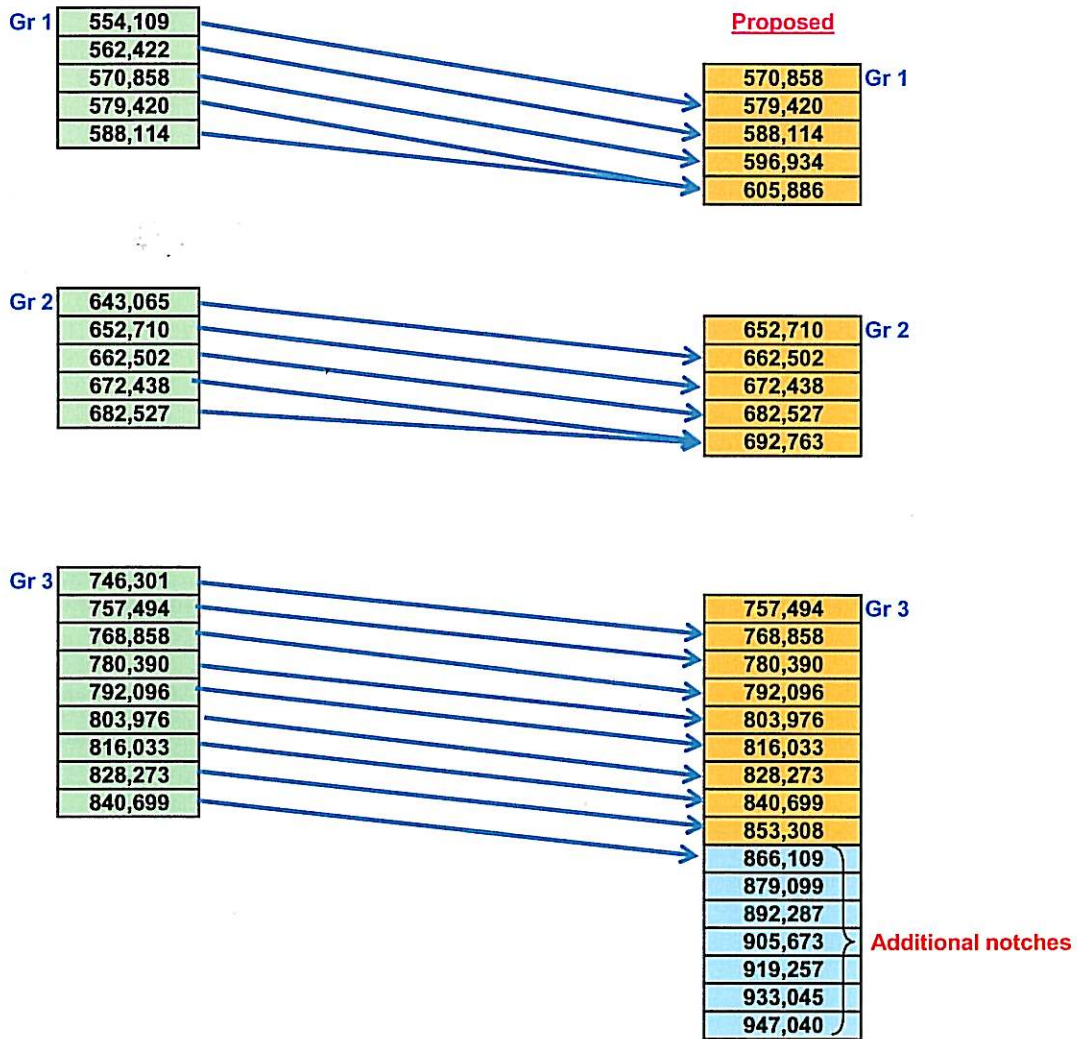

New OSD posts (levels) wef 1 Apr 2010

NONE

Head: Clinical Unit (Clinical Pharmacology)/(Stomatology)

892,287	Gr 1
905,673	
919,257	
933,045	
947,040	

975,666	Gr 2
990,300	
1,005,153	
1,020,231	
1,035,534	
1,051,068	
1,066,833	

New OSD posts (levels) wef 1 Apr
2010

NONE

Head: Clinical Department (Clinical
Pharmacology)/(Stomatology)

1,115,565	Gr 1
1,132,299	
1,149,285	
1,166,523	
1,184,019	

1,219,809	Gr 2
1,238,106	
1,256,679	
1,275,528	
1,294,662	

Non-clinical Medical & Dental Management

Asst Man. Medical Services
Asst Man. Dental Services

The OSD post (work level) Asst Manager: Medical/Dental Services is abolished, and incumbents are translated to the OSD post (work levels) Medical Manager: Medical/Dental Services

430,206
436,656
443,208
449,856
456,606
463,452
470,406
477,462
484,623
491,892

Manager Medical Services
Manager Dental Services

506,757
514,359
522,072
529,905
537,855
545,922
554,109
562,422
570,858
579,420
588,114

Manager Medical Services
Manager Dental Services

Proposed

605,886	Grade 1
614,976	
624,198	
633,561	
643,065	
652,710	
662,502	
672,438	

692,763	Grade 2
703,155	
713,700	
724,407	
735,273	
746,301	
757,494	
768,858	
780,390	
792,096	

Snr Man. Medical Services
Snr Man. Dental Services

App: 10 Yrs

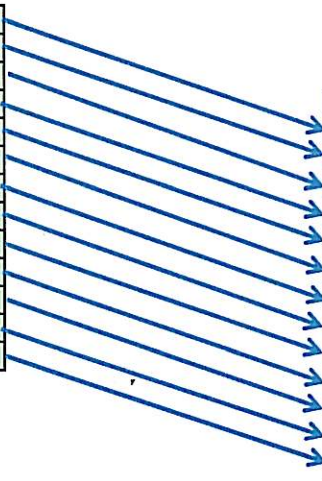
746,301		Proposed
757,494		780,390
768,858		792,096
780,390		803,976
792,096		816,033
803,976		828,273
816,033		840,699
828,273		853,308
840,699		866,109
853,308		879,099
866,109		892,287
879,099		905,673
892,287		919,257
	933,045	
	947,040	

General Man. Medical Services
General Man. Dental Services

12 Yrs

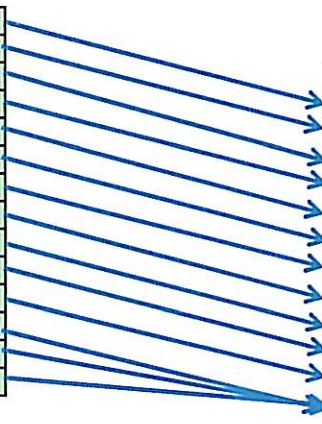
905,673		Proposed
919,257		933,045
933,045		947,040
947,040		961,248
961,248		975,666
975,666		990,300
990,300		1,005,153
1,005,153		1,020,231
1,020,231		1,035,534
1,035,534		1,051,068
1,051,068		1,066,833
1,066,833		1,082,835
1,082,835		1,099,077
1,099,077	1,115,565	

Pharmacist

General Pharmacy stream

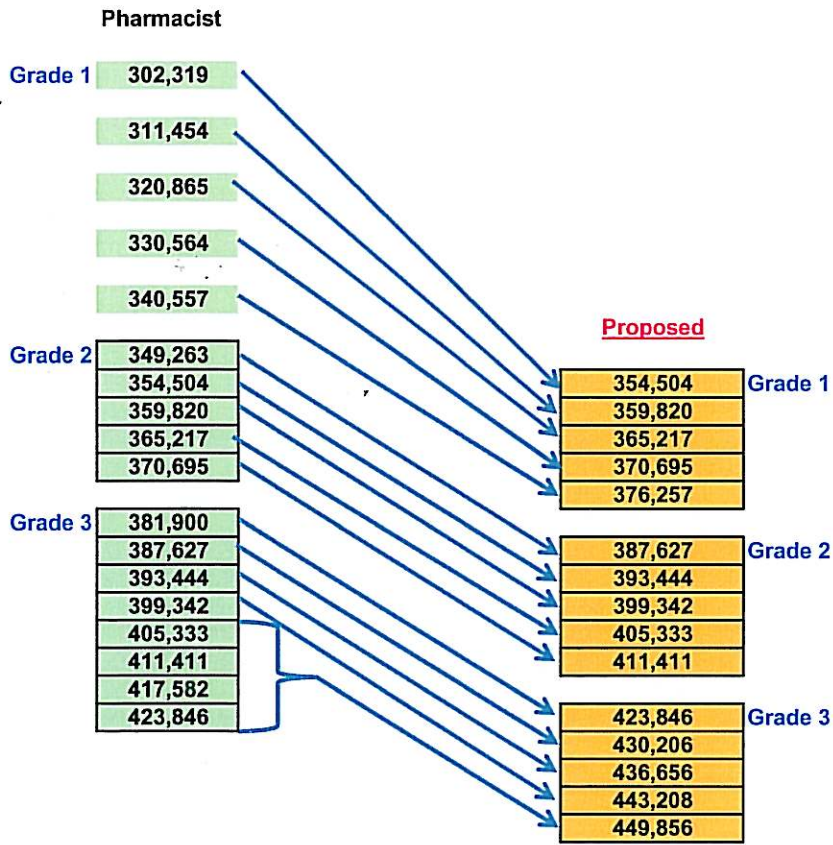

Pharmacists, who were Senior or Principal Pharmacists (salary levels 8 and 9) pre-OSD, and who occupied a post where it was required to formally supervise more than one post of Pharmacist (pre-OSD), are eligible for translation to the OSD post Pharmacy Supervisor

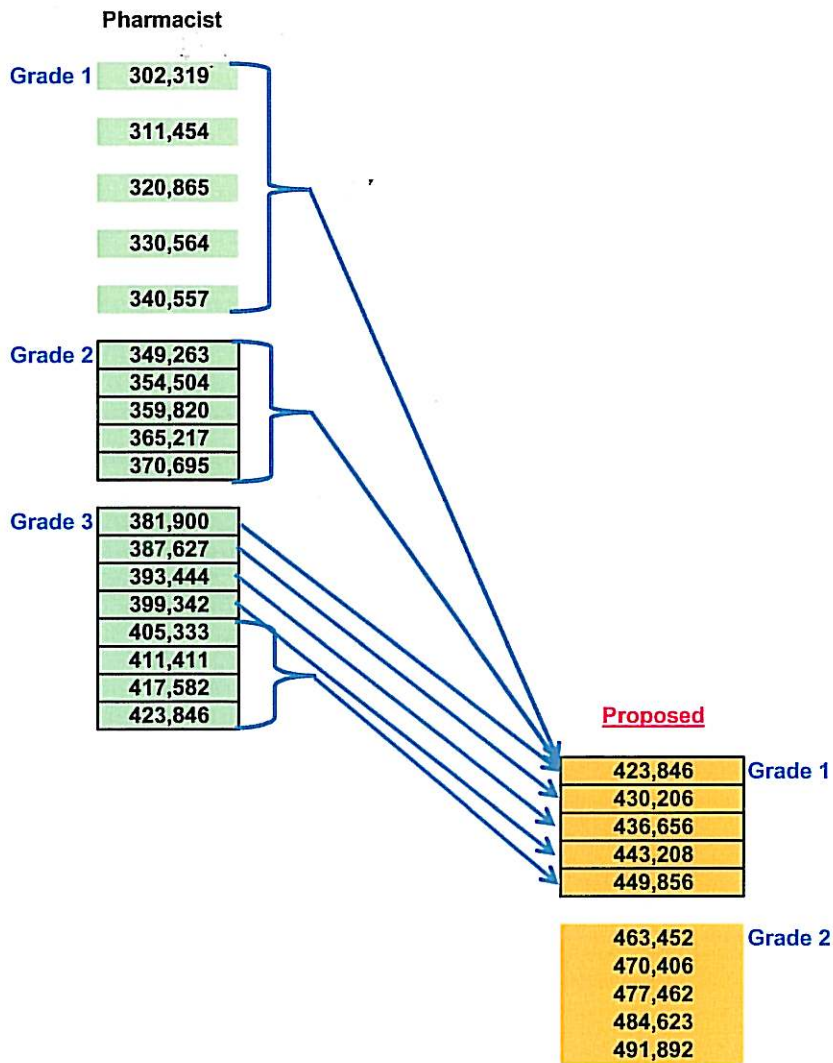

**Pharmacy
Supervisor**

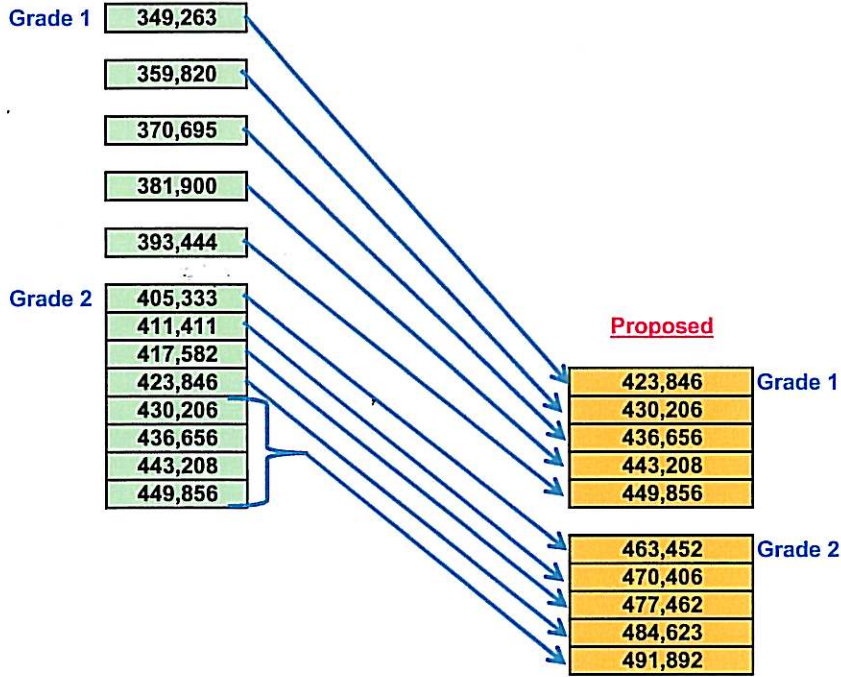

**Asst Man
Pharmaceutical
Services**

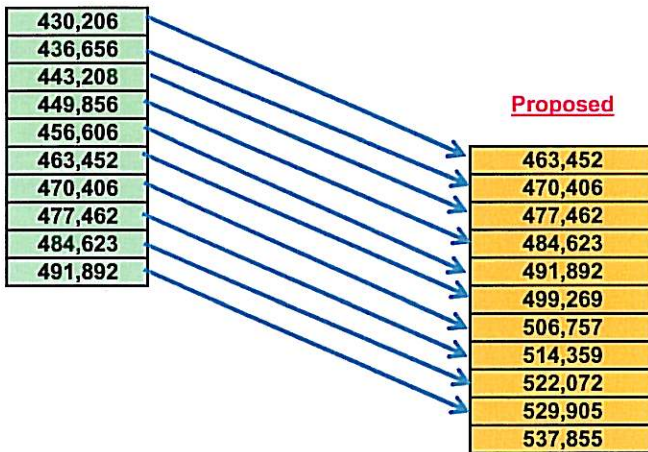

Dep Man
Pharmaceutical
Services

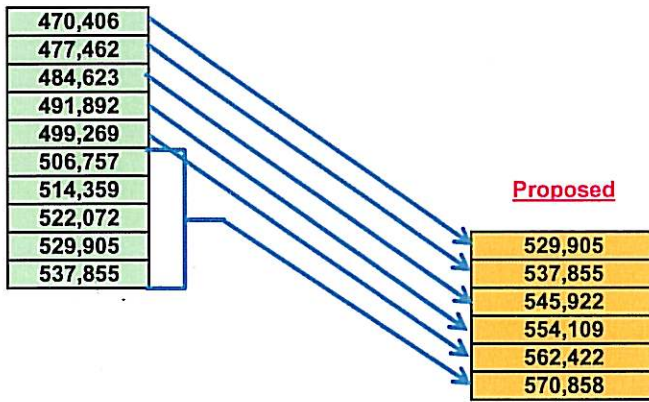

Manager
Pharmaceutical
Services

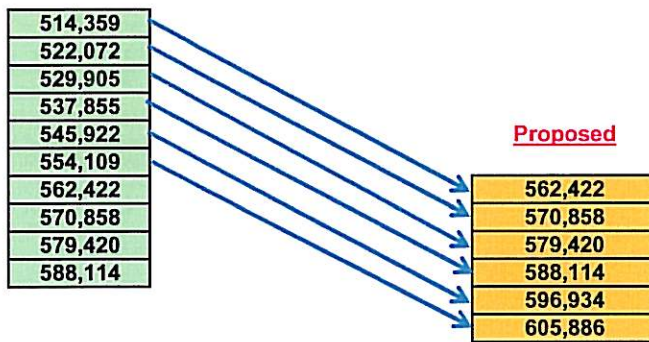

Dir: Pharmaceutical services (SMS) or equivalent

Senior Manager:
Pharmaceutical Services (OSD post)

SMS post is de-SMS'd wef 1 April 2010 - Post requirement that incumbent must be registered as Pharmacist with SACP, and must retain registration on a continuous basis

652,572	682,527
662,358	692,763
672,297	703,155
682,380	713,700
692,616	724,407
703,008	735,273
713,553	746,301
724,257	757,494
735,120	768,858
746,148	780,390
757,338	
768,702	
780,228	

Clinical stream

Clinical Pharmacist

Grade 1

430,206
436,656
443,208
449,856
456,606
463,452
470,406
477,462

No Translation - stream not activated yet

Proposed

Grade 1

463,452
470,406
477,462
484,623
491,892

Grade 2

491,892
499,269
506,757
514,359
522,072
529,905
537,855

Grade 2

506,757
514,359
522,072
529,905
537,855

Policy stream

Pharmaceutical Policy Specialist

Grade 1

430,206
436,656
443,208
449,856
456,606
463,452
470,406
477,462

No Translation - stream not activated yet

Proposed

Grade 1

463,452
470,406
477,462
484,623
491,892

Grade 2

491,892
499,269
506,757
514,359
522,072
529,905
537,855

Grade 2

506,757
514,359
522,072
529,905
537,855

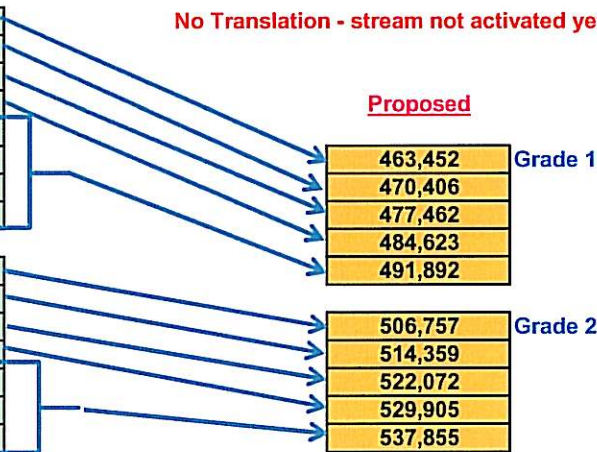

Senior
Pharmaceutical
Policy
Specialist

	<u>Proposed</u>
514,359	529,905
522,072	537,855
529,905	545,922
537,855	554,109
545,922	562,422
554,109	570,858
562,422	579,420
570,858	588,114
579,420	596,934
588,114	605,886

Paramedic

Minimum requirement for appointment: Registration as Paramedic or Emergency Care Practitioner (ECP)

Broadband

Registered as Paramedic (CCA qualified) - Grades 1, 2, 3 and 4 apply (**UNCHANGED**)

Registered as Paramedic (Nat Diploma) - Grades 2, 3 and 4 apply (**AMENDED**)

Registered as Emergency Care Practitioner (B.Tech Degree or higher qualification) - only Grades 3 and 4 apply (**AMENDED**)

Please note that scales remain unchanged!!!

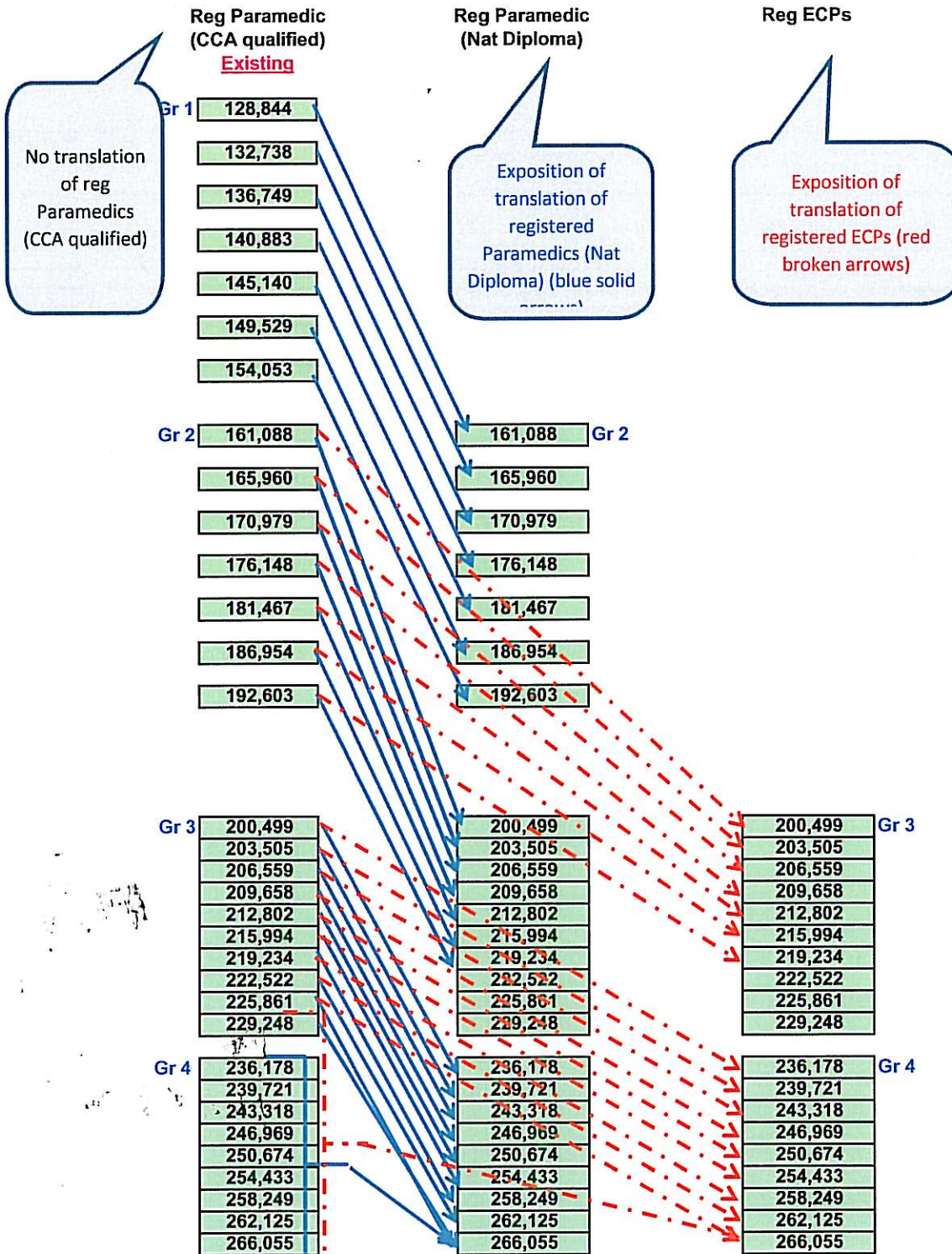

EMS Lecturer (Paramedic)

Minimum requirement for appointment: Registration as Paramedic or Emergency Care Practitioner (ECP)

Broadband

Registered as Paramedic (CCA qualified) - Grades 1, 2, 3 and 4 apply **(UNCHANGED)**

Registered as Paramedic (Nat Diploma) - Grades 2, 3 and 4 apply **(AMENDED)**

Registered as Emergency Care Practitioner (B.Tech Degree or higher qualification) - only Grades 3 and 4 apply **(AMENDED)**

Please note that scales remain unchanged!!!

